







7315 Blanco-White
LED 35W 3000k 3500lm

7316 Blanco-White
LED 35W 4000k 3850lm

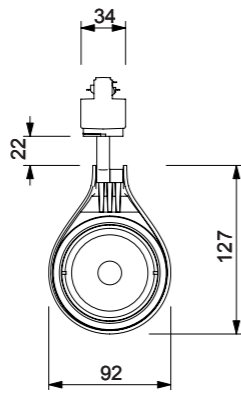
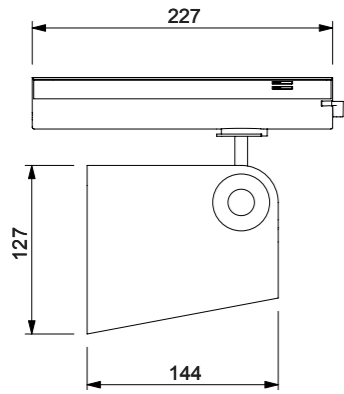

Lentes-Lens
ref 7319_13°
ref 7320_24°
ref 7321_38° Included.



Panal de abeja-Honeycomb
ref 7322

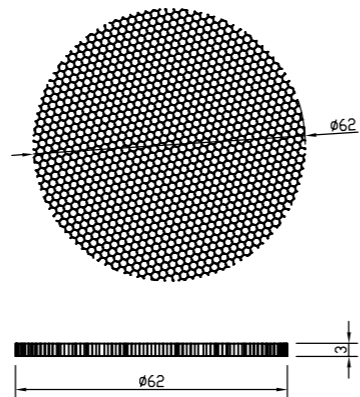

Aluminio-Aluminium 220-240V~50/60Hz CRI > 90



DRIVER
TUV

Registered N° 007663331-0017



7317 Negro-Black
LED 35W 3000k 3500lm

7318 Negro-Black
LED 35W 4000k 3850lm



Luminous Intensity Distribution Curve

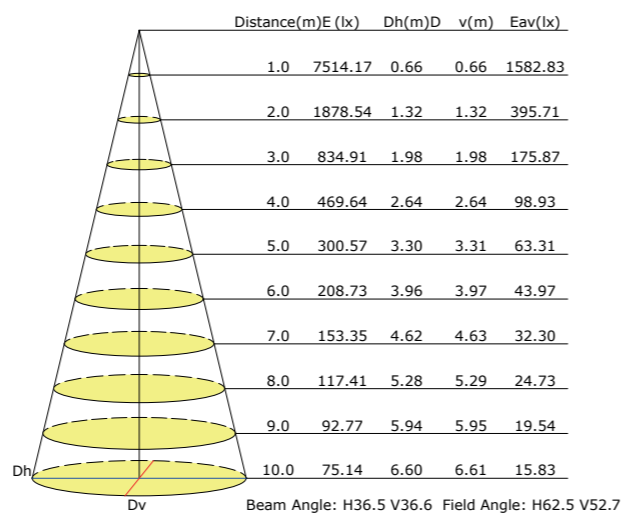
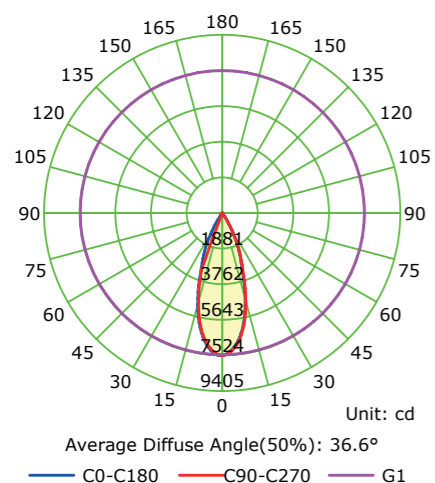

Lentes-Lens
ref 7319_13°
ref 7320_24°
ref 7321_38° Included.



Panel de abeja-Honeycomb
ref 7322

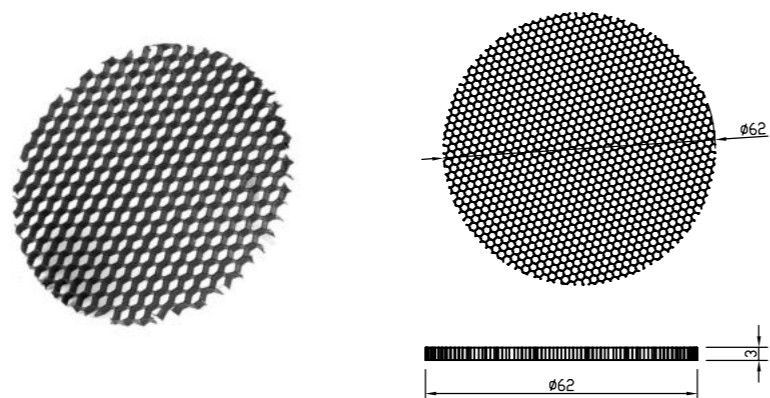

Aluminio-Aluminium 220-240V~50/60Hz CRI > 90

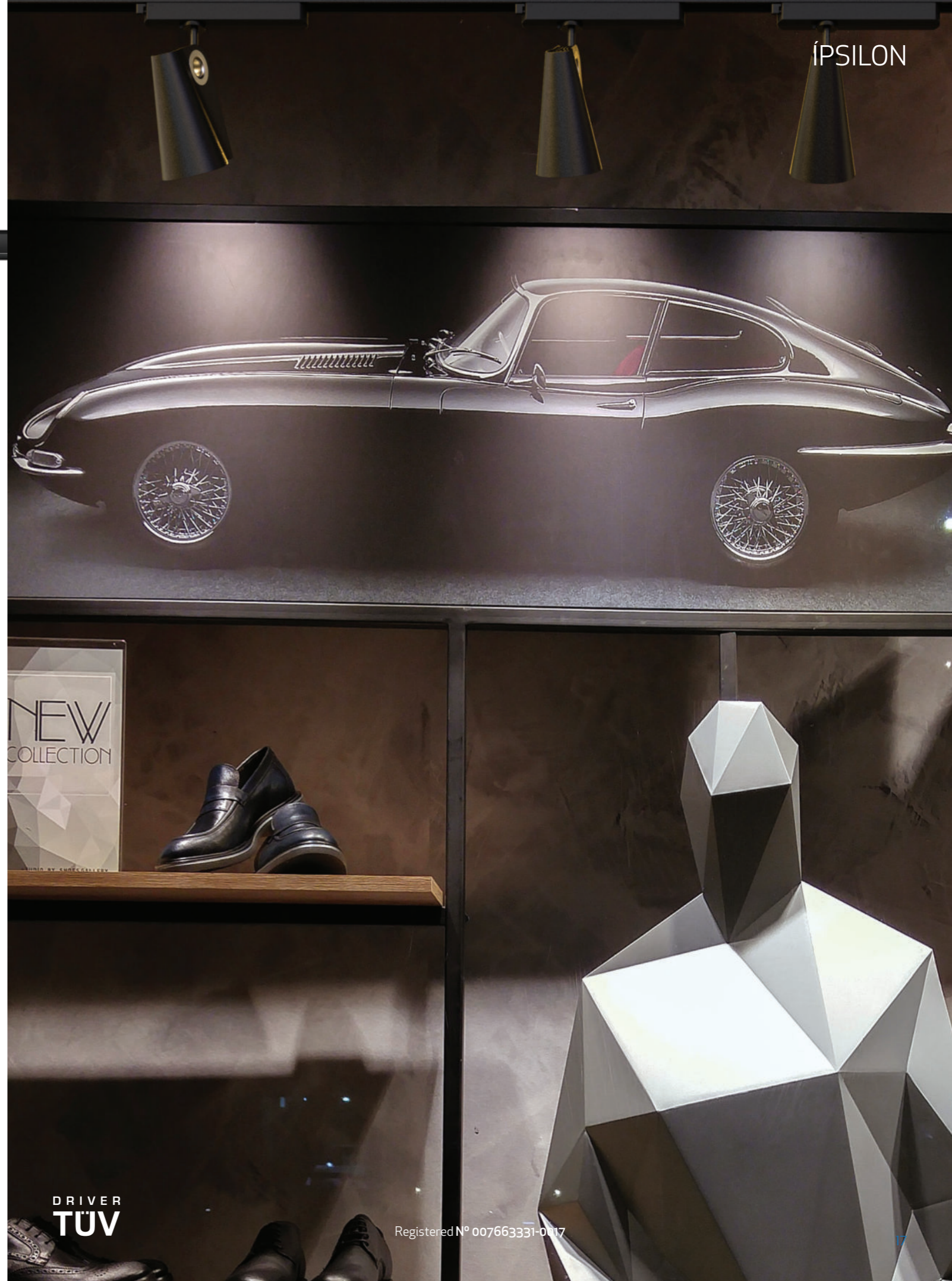

DRIVER TÜV

Registered N° 007663331-0117